

SAUNA - THEICEBATHNZ



Aurora 4 Person Infrared Sauna

theicebathnz.co.nz

TABLE OF

This guide includes everything you need to set up, use, and maintain your Aurora Infrared Sauna. From installation tips to Wi-Fi setup and cleaning instructions, each section is designed to help you operate your unit with ease.

ELECTRICAL REQUIREMENTS.....	02
COMPONENT	03
INSTALLATION INSTRUCTIONS.....	04
OXYGEN IONIZER.....	09
SAUNA ACCESSORIES.....	10
CONTROL PANEL.....	11
OPERATING INSTRUCTIONS.....	12
HOW TO USE THE APP.....	14
USAGE GUIDE.....	16
WOOD CARE.....	17
SAUNAS AND CONTRAINDICATIONS.....	18
TROUBLESHOOTING GUIDE.....	19

01

ELECTRICAL REQUIREMENTS



Please read thoroughly and ensure all electrical requirements are met before installation. Failure to follow these guidelines may result in electrical hazards, reduced performance, or voided warranty.

- 1** A dedicated circuit is required, meaning no other appliances should share the outlet or circuit with the sauna. Failure to comply may result in electrical interruptions and reduced performance.
- 2** It is highly recommended that a qualified electrician install your dedicated electrical wiring to ensure proper sauna functionality and to avoid potential electrical hazards.
- 3** Ensure the sauna is properly grounded to prevent serious injury or electrical risks.
- 4** Follow all installation instructions carefully and position the sauna in a dry, hazard-free location, away from water sources or liquids.
- 5** Do not expose the heater elements to water or liquids, as this may cause electric shock. If you have any concerns, contact the Verve service team immediately.

AU Plug Requirements

The Aurora 4-Person Sauna requires a 15 Amp AU plug due to its size, voltage, and power requirements.

Unless the customer already has a 15 Amp circuit, a professional electrician will need to install one before use.



COMPONENT

COMPONENT

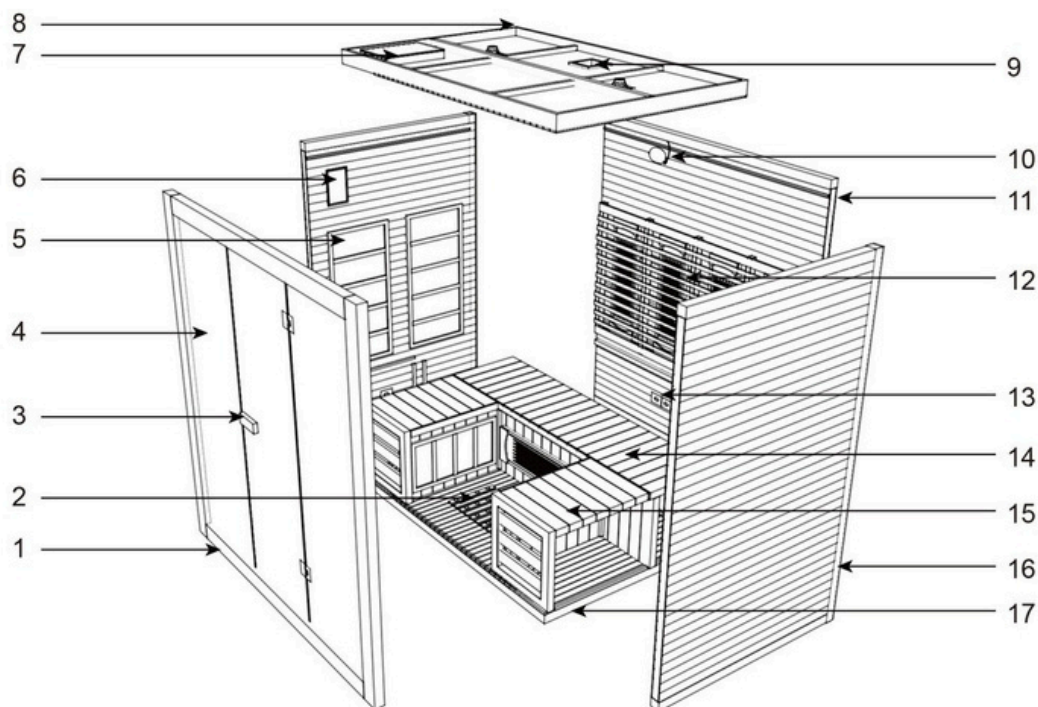

No.	Part Name	No.	Part Name
1	Front Panel	10	Oxygen Ionizer
2	Foot Sole Heater with Tourmaline	11	Rear Panel
3	Door Handle	12	Infrared Full Spectrum Heater
4	8MM Tempered Glass	13	Heaters Socket under The Bench
5	Infrared Carbon Heating Panel	14	Bench
6	Control Panel	15	Side Bench
7	Electrical box (electrical control system)	16	Side Panel
8	Top Panel	17	Floor Panel
9	Ventilation skylight	/	/

INSTALLATION INSTRUCTIONS

Steps to Use the Buckle System

Ensure all panels are properly aligned and secured using the buckle system before proceeding with assembly.

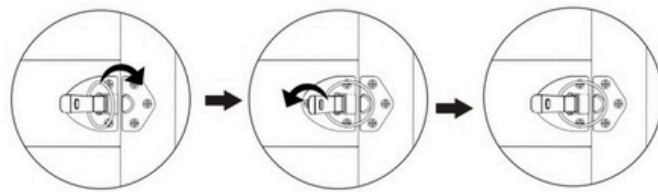

STEP ONE

Floor Panel Installation

Place the base obverse.

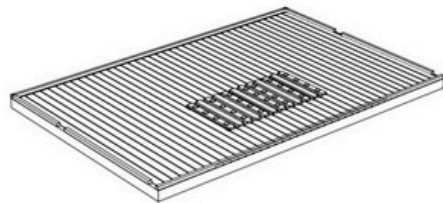

STEP TWO

Rear Panel

Place the rear panel on the back end of the floor panel. At this point, someone should hold the rear panel while another person inserts the rear panel to the floor panel.

Note: It is recommended to construct back, left & right sides BEFORE inserting to ensure alignment.

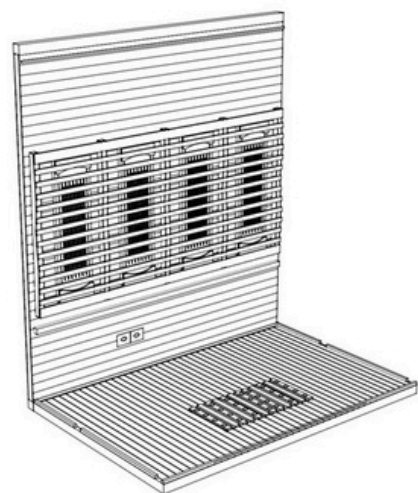

INSTALLATION INSTRUCTIONS

STEP THREE

Right Panel

Install the right panel as shown. Ensure that all panels are flat and level at the top.

Tip: Secure the right panel tightly to the floor panel before proceeding to the next step.

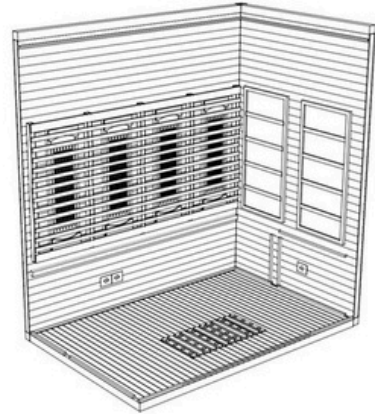

STEP FOUR

Bench Installation

Some sauna models include a square bench support. If applicable, place it in front of the windows.

1. Slide the bench stand panel between the two vertical guides on the side panels.
2. Connect the heaters' plugs under the bench to the appropriate sockets.
3. Install the bench top by placing it on top of the bench stand and the horizontal guide on the rear panel. Make sure the smooth and finished side is facing up and forward.

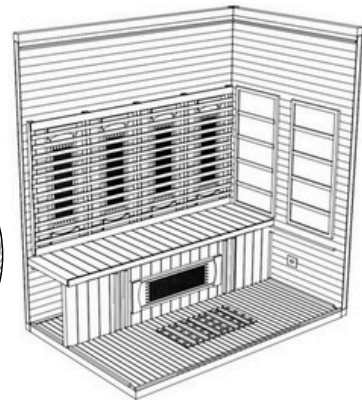
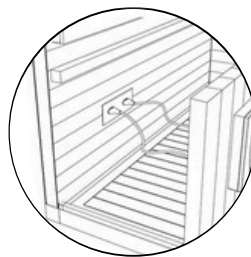
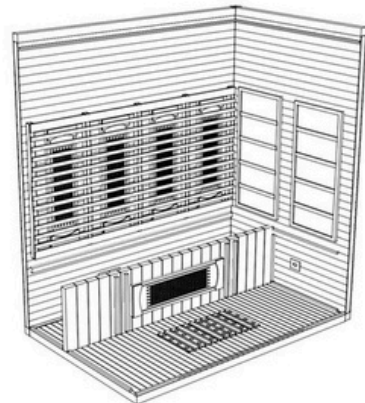

INSTALLATION INSTRUCTIONS

STEP FIVE

Left Panel

Install the left panel, ensuring it is positioned correctly using the Up direction mark. Make sure the tops of both panels are flat and level.

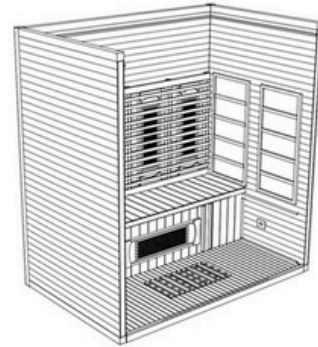

STEP SIX

Front Panel

1. Attach the glass fixed panel to the front panel using the screws.
2. Fix the glass door to the glass panel using the hinges.

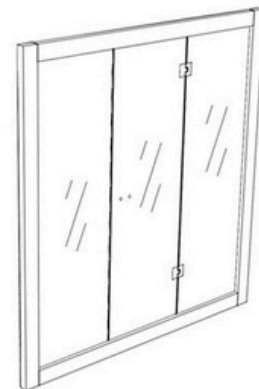
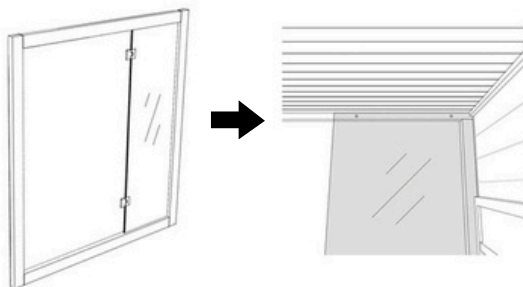

3. Secure the front panel to both side panels.
4. Insert the front panel at the front of the sauna as shown in the diagram.
5. Ensure all panels are properly aligned and secured using the buckle to fix it.

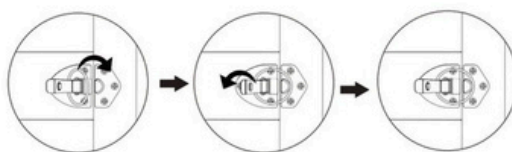

Tips: Align the corners of the side panels with the edges of the front panel. The front panel is heavy due to the glass, so at least two people are required for lifting. The metal magnetic clips on the glass door can slide up and down to align with the magnetic catches.

INSTALLATION INSTRUCTIONS

STEP SEVEN

Top Panel

Lift the top panel over the sauna body:

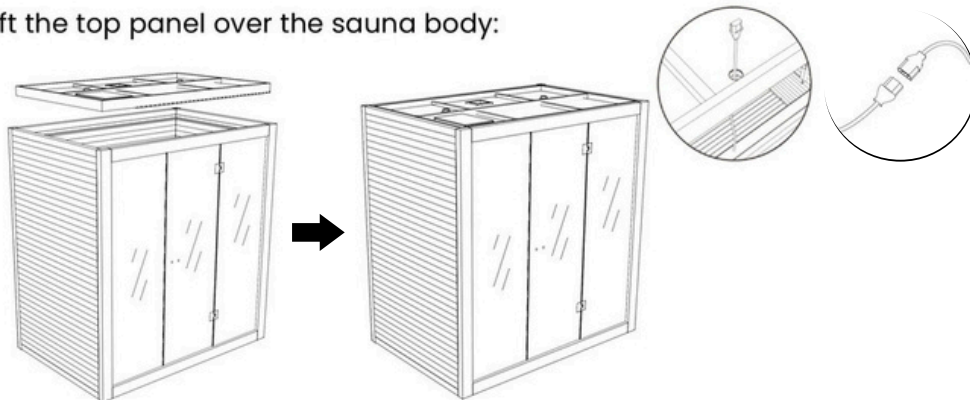

1. Insert the wires for the control panel, temperature sensor, and heaters through the openings in the ceiling.
2. Connect the control panel wire (white ribbon) and heat sensor (2-pin wire) on top of the sauna.
3. Plug the heater connectors into the control box. Even though the heater plugs may be labelled, they can connect to any socket on the control box.
4. Place the dust cover over the sauna roof and pass the main power plug through the hole.
5. Match the dust cover vent holes with the sauna vent holes.

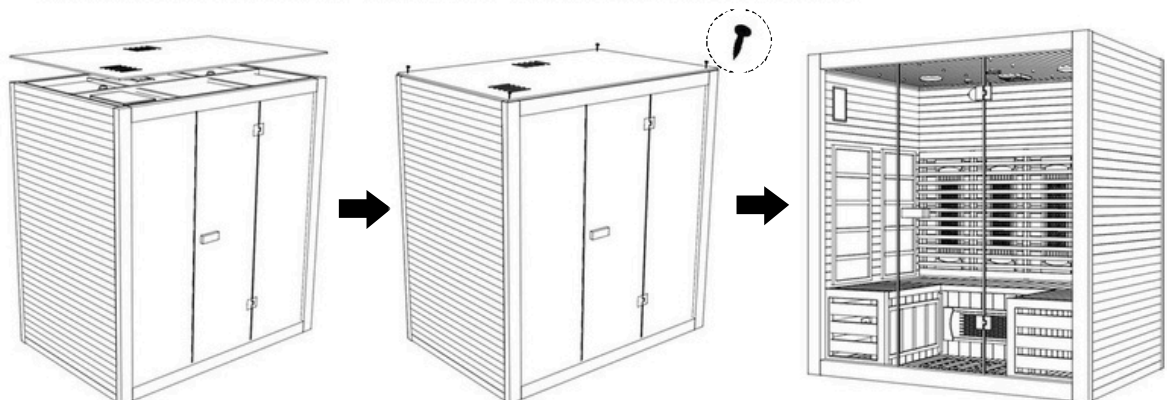

Secure the dust cover to the top panel using the small black screws

INSTALLATION INSTRUCTIONS

STEP EIGHT

Install the Left & Right side benches after finishing glass installation.

1. The sauna includes a square bench support for each side. Please place it in front of the windows.

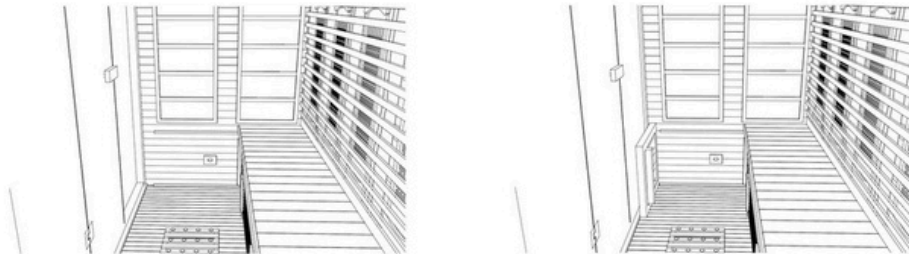

2. After placing the bench stand panel, and connect the heater plugs to the corresponding sockets.

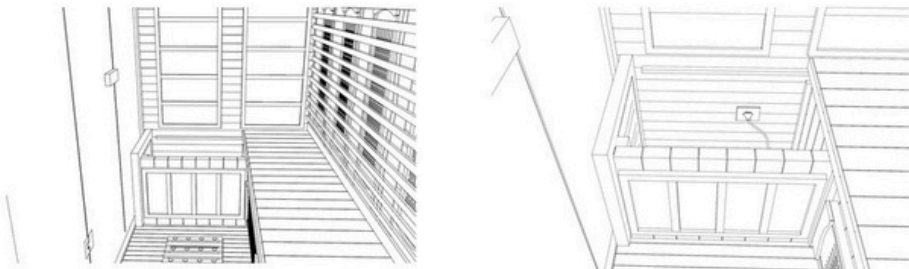

3. Slide the bench top panel over the horizontal guide on the side panels. Ensure the smooth, finished side faces up and forward.

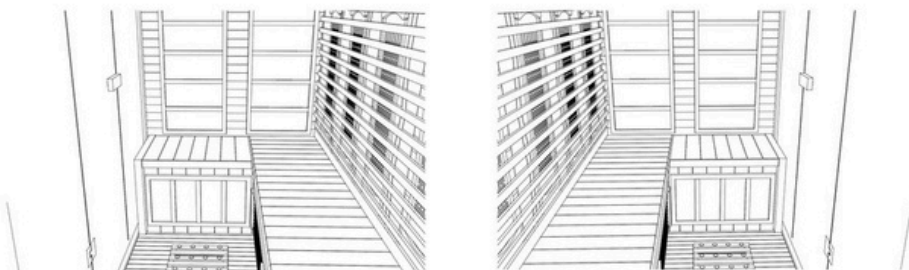

Left side

Right side

08

OXYGEN IONIZER INSTALLATION

Choose a suitable location and secure the oxygen ionizer to the sauna using screws. Connect the top wire to the oxygen ionizer

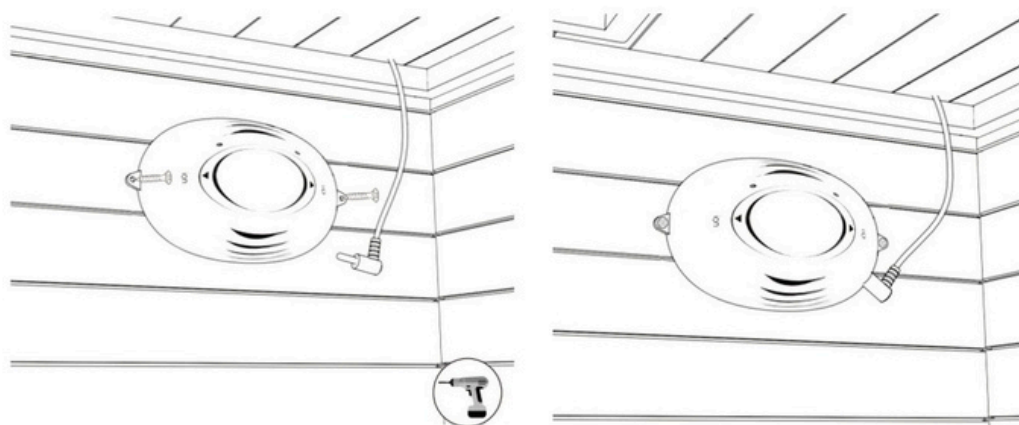

Locate the ionizer plug that extends from the sauna ceiling (1-pin plug). Connect the oxygen ionizer and screw it onto the back panel.

The oxygen ionizer purifies the air inside the sauna by eliminating odour-causing bacteria and removing airborne particles.

Usage

- Before and during sauna use: Select the "Ion" option to remove airborne particles.
- After using the sauna: Select the "O3" option to eliminate odour-causing bacteria from the sauna air.



SAUNA ACCESSORIES

Knob (Full-Spectrum Heating Control)

The knob is pre-installed on the back panel and does not require additional installation.

- This knob allows you to adjust the heat and brightness of the full-spectrum heating tubes located on the back panel and leg area.
- Turning the knob fully to the right (100%) sets the heaters to their maximum brightness and heat level.
- Turning it fully to the left (20%) lowers the heaters to minimum brightness and heat output.

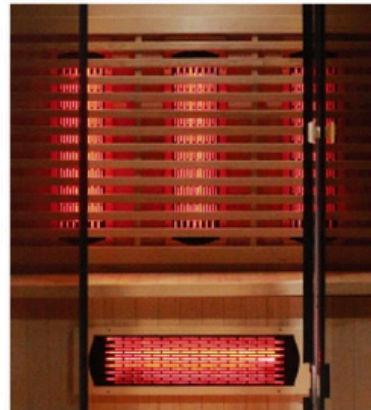

Default Setting

The sauna is pre-set to 100% (maximum heat and brightness). If the back panel or leg area feels too hot, turn the knob counterclockwise to adjust to a more comfortable setting.



Colour Therapy Lights

Some sauna models come with colour therapy lights. These lights are operated using the remote control.

- Press any colour on the remote control to turn the lights on and select a colour.
- Press the Cycle button (lower right button) to cycle through colours randomly.
- Press the Power button to turn the lights off.

CONTROL PANEL OPERATIONS

This section outlines the operating instructions for your sauna system, detailing how to use its various features and functions effectively for a customised and safe experience.

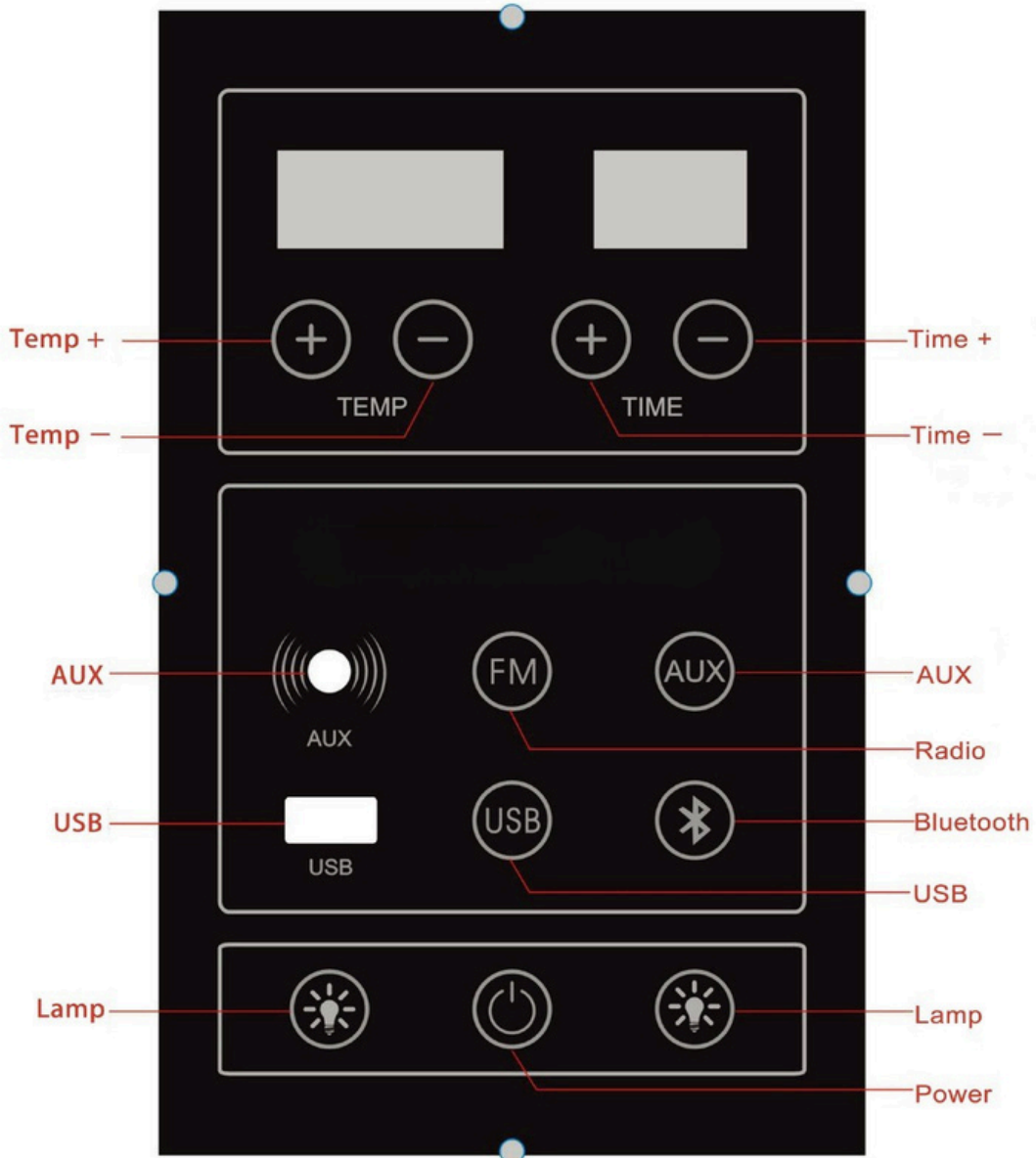

OPERATING INSTRUCTIONS

Turn On/Off the Light Wave

- Press the ON/OFF button  to toggle the light wave on or off.
- When powered on: The first press turns on the light wave, and the second press turns it off.
- The last set temperature (30-70°C) is remembered by the system.
- The default operation time is 90 minutes.

Temperature Setting

- After turning on the light wave, press TEMP + or TEMP - to adjust the temperature within the range of 30-70°C.
- Each press increases or decreases the temperature by 1°C.
- If the temperature is set below 30°C, the display will show "--".
- To switch between Fahrenheit and Celsius, press and hold the TEMP + button for 30 seconds.

Time Setting

- Press TIME + or TIME - to adjust the session duration within the range of 5-90 minutes.
- When the countdown reaches 0, the buzzer sounds three times, with an interval of 1.5 seconds.

Lamp Function

- Basic Light Operation: With the light wave turned on, press the Lamp button to switch the light on or off.
- Supported light power: AC220V 50W (DC12V lamps require an external switching power supply).

LED Colour Settings:

- Press the LED button  to activate colour selection.
- The clock area will show "2n" and the temperature display will show "Lx."
- Spotlight Control: In the "2n" state, press TIME + or TIME - to switch LED lights and spotlights on or off independently.
- Press the LED button to cycle through colour modes. After 8 seconds without pressing, the display exits the light control menu, retaining the current settings.

Colour Modes

L1: Full bright	L4: Blue-green	L7: Red
L2: Red-blue	L5: Green	L8: Jump mode
L3: Blue	L6: Green-red	L9: Gradient mode

OPERATING INSTRUCTIONS

Audio Function



1. FM Radio

- Press the Radio button to enable FM radio.
- The temperature display shows the frequency, and the clock display shows the volume.
- Use TEMP +/- to adjust the frequency and TIME +/- to adjust the volume.
- The display returns to temperature and time after 8 seconds of inactivity.



2. AUX

- Press the AUX button to activate AUX mode.
- The temperature display shows "AUX," and the clock display shows the volume.
- Adjust the volume using TIME +/-.



3. USB

- Press the USB button to activate USB playback.
- Use TEMP +/- for track navigation and TIME +/- to adjust volume.
- USB read time: 2-3 seconds.



4. Bluetooth

- Press the Bluetooth button to enable pairing mode.
- The temperature display shows "B," and the clock display shows the volume.
- Pair your mobile device within 6-7 seconds.

High Temperature Protection Function

- If the sensor temperature exceeds 70°C:
- The display shows "HH," an alarm sounds, and all functions stop.
- To resume operation, power off and restart the unit after cooling.

Sensor Fault Detection

- Open Circuit: Displays "00," flashes, and triggers an alarm. Functions cannot operate until resolved.
- Short Circuit: Displays "1," flashes, and triggers an alarm. Functions cannot operate until resolved.

HOW TO USE THE SAUNA APP

Step 1: Download the App

- Download "Smart Life" on the Google Play Store (Android) or Apple App Store (iPhone).

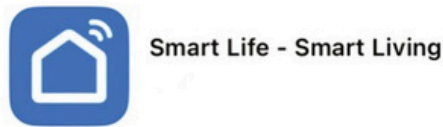

Step 2: Register an Account

- Open the Smart Life app.
- Register using your mobile phone number.
- Ensure you select the correct country/region during registration.

Step 3: Log in & Pair Your Sauna

- Log in to the Smart Life app.
- On the homepage, click the "+" in the top right corner.
- Select "Add Device" from the menu.

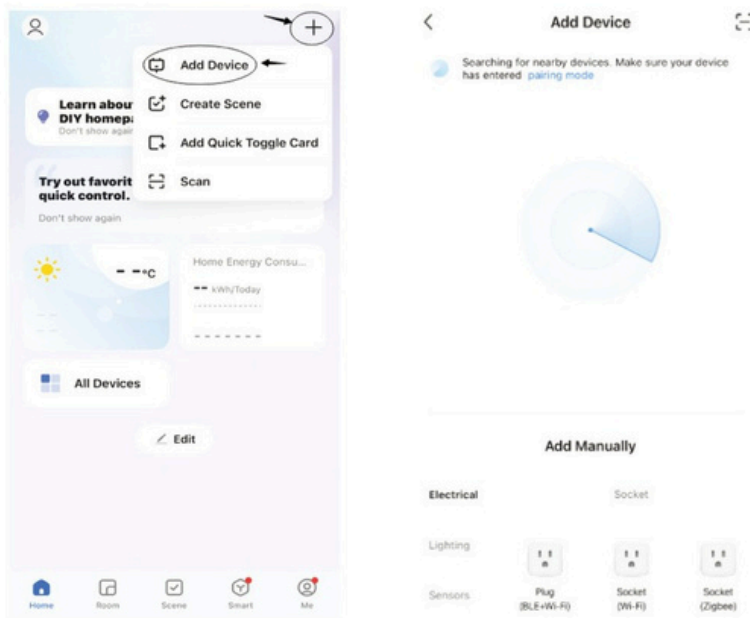

HOW TO USE THE SAUNA APP

Step 4: Connect the Sauna to Wi-Fi

- The app will search for nearby devices.
- Ensure your sauna is in pairing mode before proceeding.
- When the "Advanced Intelligent Sauna" icon appears, select it.
- Choose your home Wi-Fi network and enter the Wi-Fi password.
- Click "Next" to proceed to the control interface.

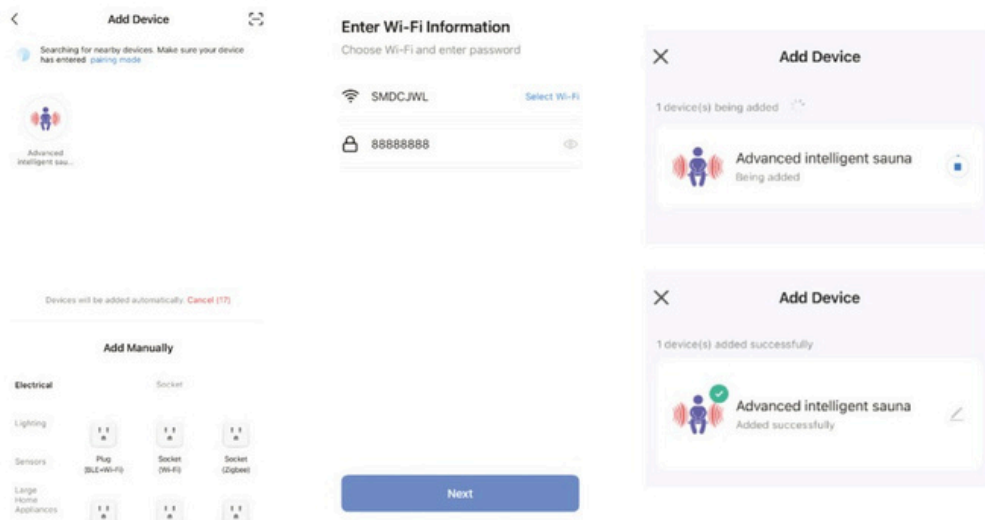

Step 5: Using the Scheduling Function

- To set a scheduled session, go to "Schedule Session" in the app.
- Click "Add", then select your preferred time, repetition frequency, and whether the sauna should turn on or off automatically.

SAUNA IS NOW CONNECTED

Once all steps are completed, you can remotely operate your sauna from your mobile phone.

If you experience connection issues, ensure your Wi-Fi is stable and your sauna is in pairing mode before retrying.

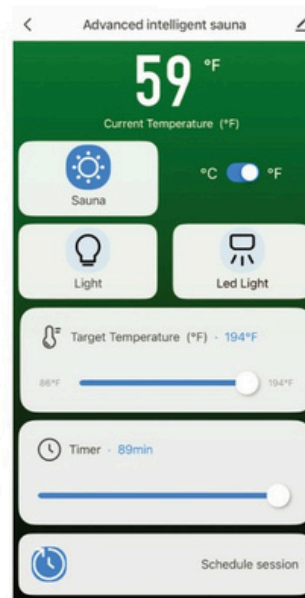

15

USAGE GUIDE

Allow your sauna to warm up for 15–20 minutes or until it reaches 110°F (43°C). To speed up the pre-heating process, you may close the ceiling vent. Ensure you drink plenty of water before and after each session to avoid dehydration. It is recommended to limit sauna use to no more than 40 minutes per session.

If the sauna becomes stuffy during use, open the ceiling vent to allow fresh air into the sauna.

Tips for Optimal Use:

- Begin your sauna session when the temperature is within 10°F of the set temperature for maximum benefits from the infrared heaters. For example, if the set temperature is 125°F (52°C), start using the sauna at around 115°F (46°C).
- Most customers report an average use temperature of 125°F (52°C).

Precautions

- If the temperature becomes unbearable, lower the temperature or turn off the sauna immediately.
- Do not use the sauna if you are pregnant, have serious inflammation, a fever, a communicable disease, acute bleeding, or are intoxicated.
- Avoid consuming alcohol or drugs while using the sauna.
- Do not splash water on the heaters or any electrical components inside the sauna.
- Avoid bringing wet towels or substances that could damage the sauna's interior.
- Do not install a lock on the sauna door.
- Repairs must be authorized by the supplier's representative; unauthorised repairs may void the product warranty.

Cleaning and Maintenance

- Use a clean, damp towel to wipe down the bench, floor, and back panel. Ensure the towel is not overly wet to prevent water from dripping inside the sauna.
- Avoid using cleaning agents inside the sauna.
- After each session, keep the sauna clean and dry by removing any towels, water glasses, or bottles left inside.
- Wipe the exterior surfaces of the sauna regularly, and clean the glass at least once a month.

WOOD CARE

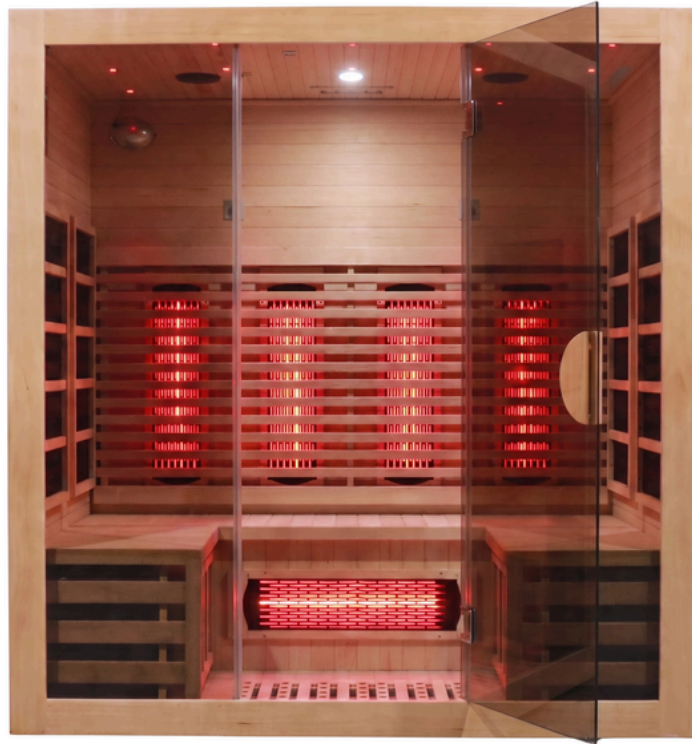

Interior Maintenance:

- For scratches or scuffs, you may choose to leave them as is, sand them, or use a combination of gluing and sanding.
- Avoid using treatments containing benzene or high concentrations of alcohol on the sauna's interior.

Exterior Maintenance:

- Minor scratches or scuffs can be concealed with furniture polish, oil, or other furniture treatments.
- For outdoor models, maintain the exterior body regularly (every 6–12 months) by polishing or resealing the wood as needed.
- If the varnish cracks or wears off, sand the surface and reapply varnish to the affected areas. Consult a local handyman or furniture repair professional for advice on maintaining wood in outdoor environments.

SAUNAS AND CONTRAINDICATIONS

Saunas and Medications

Individuals taking prescription drugs should consult their physician or pharmacist about potential effects when the body is exposed to far infrared waves or elevated temperatures.

Some medications, including diuretics, barbiturates, and beta-blockers, may impair the body's natural ability to lose heat. Additionally, over-the-counter drugs such as antihistamines may increase susceptibility to heat stroke.

Saunas and Children

Children's core body temperature rises faster than adults due to their higher metabolic rate, limited circulatory adaptation, and reduced ability to regulate temperature through sweating. Always consult a pediatrician before allowing a child to use a sauna.

Saunas and the Elderly

Older individuals may struggle to maintain core body temperature due to circulatory conditions and reduced sweat gland function. Consult a physician to ensure the body can activate natural cooling mechanisms effectively.

Saunas and Cardiovascular Conditions

Individuals with cardiovascular conditions (e.g., hypertension, hypotension, heart failure, or impaired coronary circulation) or

those taking medications affecting blood pressure should exercise caution with sauna use.

Heat stress can increase heart rate by 30 beats per minute for every degree of core body temperature increase. Consult your physician before use.

Saunas and Alcohol

Avoid using a sauna to "sweat out" a hangover. Alcohol impairs judgment and increases heart rate, which can be exacerbated by heat stress.

Saunas and Chronic Conditions

Conditions that impair the ability to sweat or perspire, such as Parkinson's, Multiple Sclerosis, Central Nervous System Tumors, or Diabetes with Neuropathy, may be negatively impacted by sauna use. Consult your doctor before proceeding.

Saunas and Hemophiliacs / Bleeding Disorders

Infrared saunas should not be used by individuals predisposed to bleeding or by hemophiliacs.

TROUBLESHOOTING GUIDE

The Sauna Doesn't Power On

- Ensure the power cord is securely connected to both the power socket and the control box (located on top of the sauna).
- Check that the breaker has not been tripped.
- Verify the control panel white ribbon wire is securely connected.
- Test the power socket by plugging in another device to confirm it is functioning properly.

Light Is Not Working

- Replace the light bulb.

Colour Therapy Light Doesn't Work

- Confirm the battery is inserted correctly in the remote.
- Point the remote directly at the receiver (small rounded tip near the colour lights).
- Try replacing the battery with a new one.

All Heaters Are Not Working

- Ensure all heater plugs are securely connected to the control box (located on top of the sauna).
- Verify the sauna is connected to the recommended power supply.
- Check that the heat sensor is securely connected.

One or a Few Heaters Are Not Working

- Confirm that all heater plugs are securely connected to the control box.
- Check that the under-bench heater plugs are securely connected.
- Note: Floor heaters and under-bench heaters are intentionally less hot than other heaters (by design).
- If necessary, check the plug behind the heater. (You may need to unscrew the heater to access it.)

Control Panel Display Is Unusual

- If the temperature display shows 150°C or 230°F, check that the heat sensor is securely connected.
- If the time display shows two dashes ("--"), the sauna is in continuous working mode. Press the timer button to switch to timed working mode.